

GRUNDRISS ALLGEMEIN

Grundriss mit allen Räumen

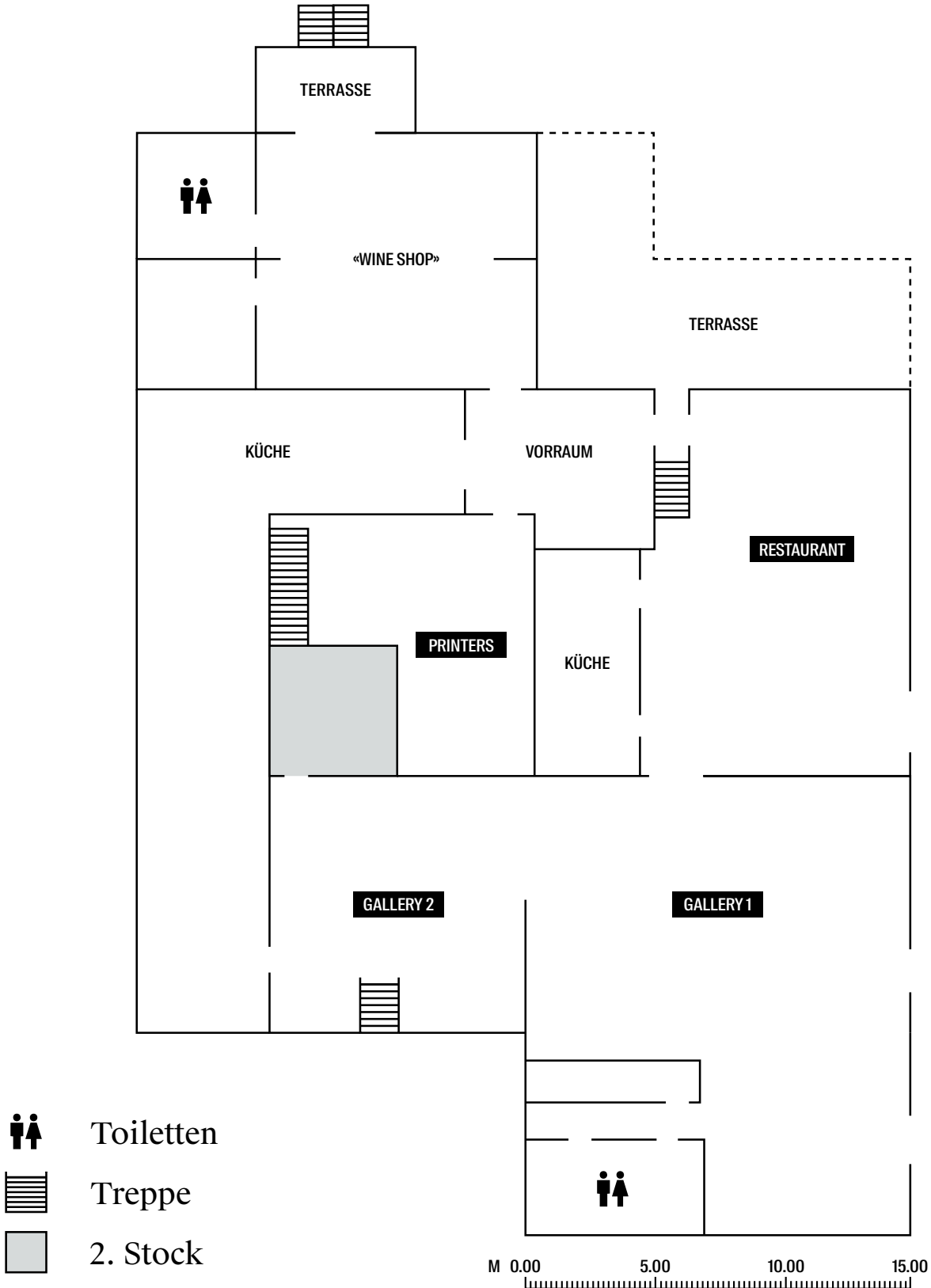

GRUNDRISS RESTAURANT

Grösse: 160 m²
Setting: Dinner
Personen: 80

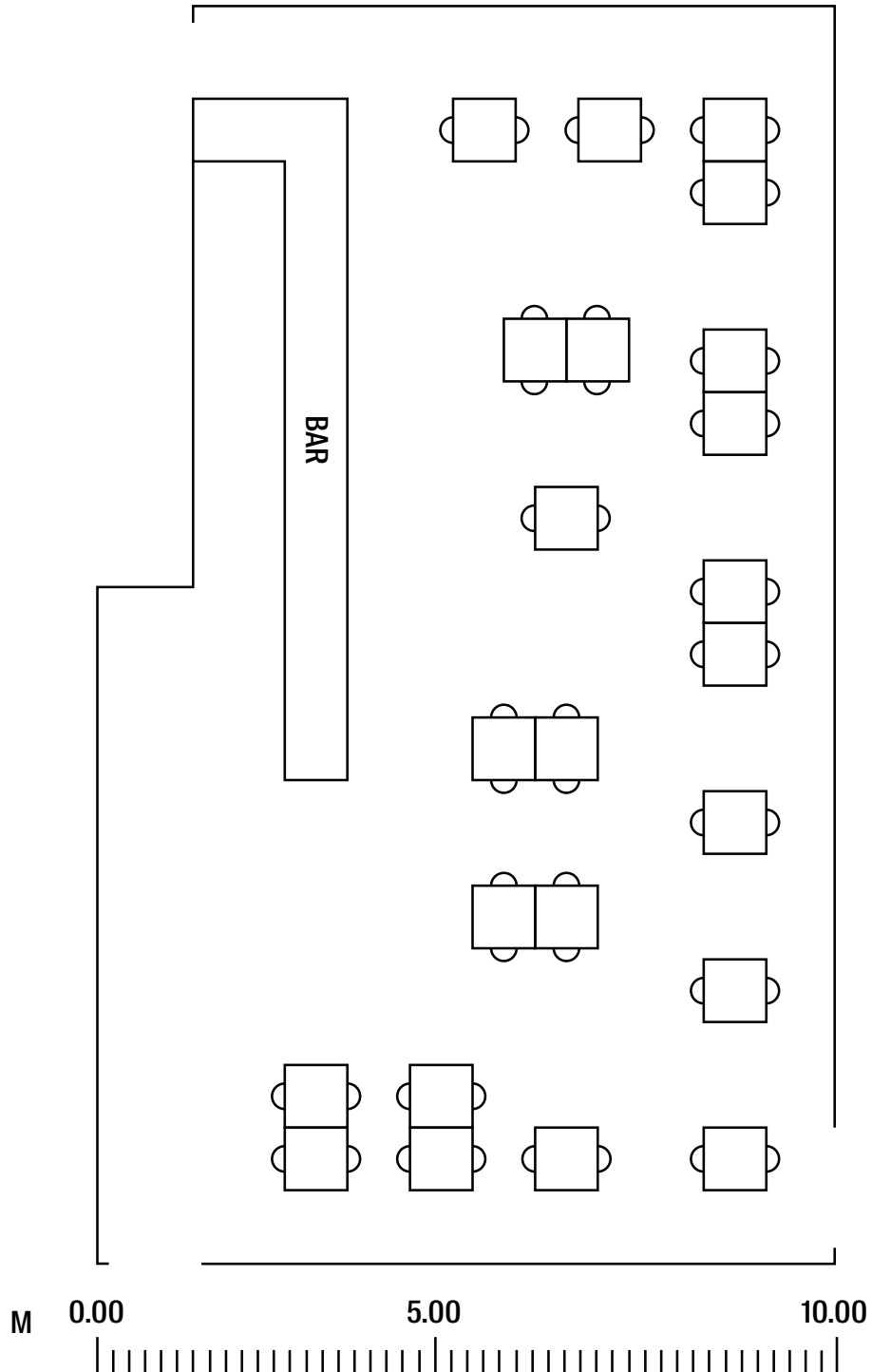

 Tische

GRUNDRISS RESTAURANT



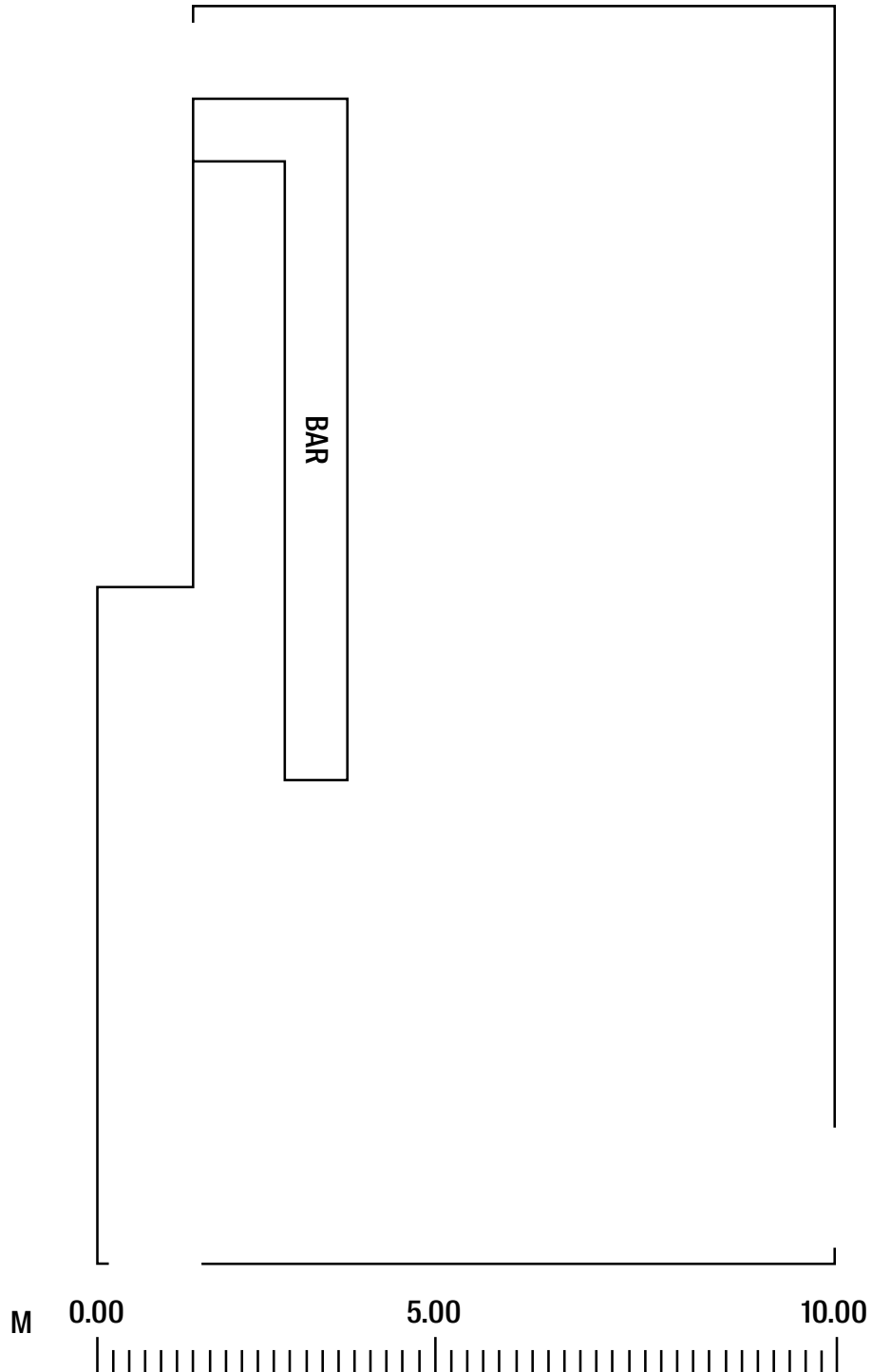

Grösse: 160 m²
Setting: Leer

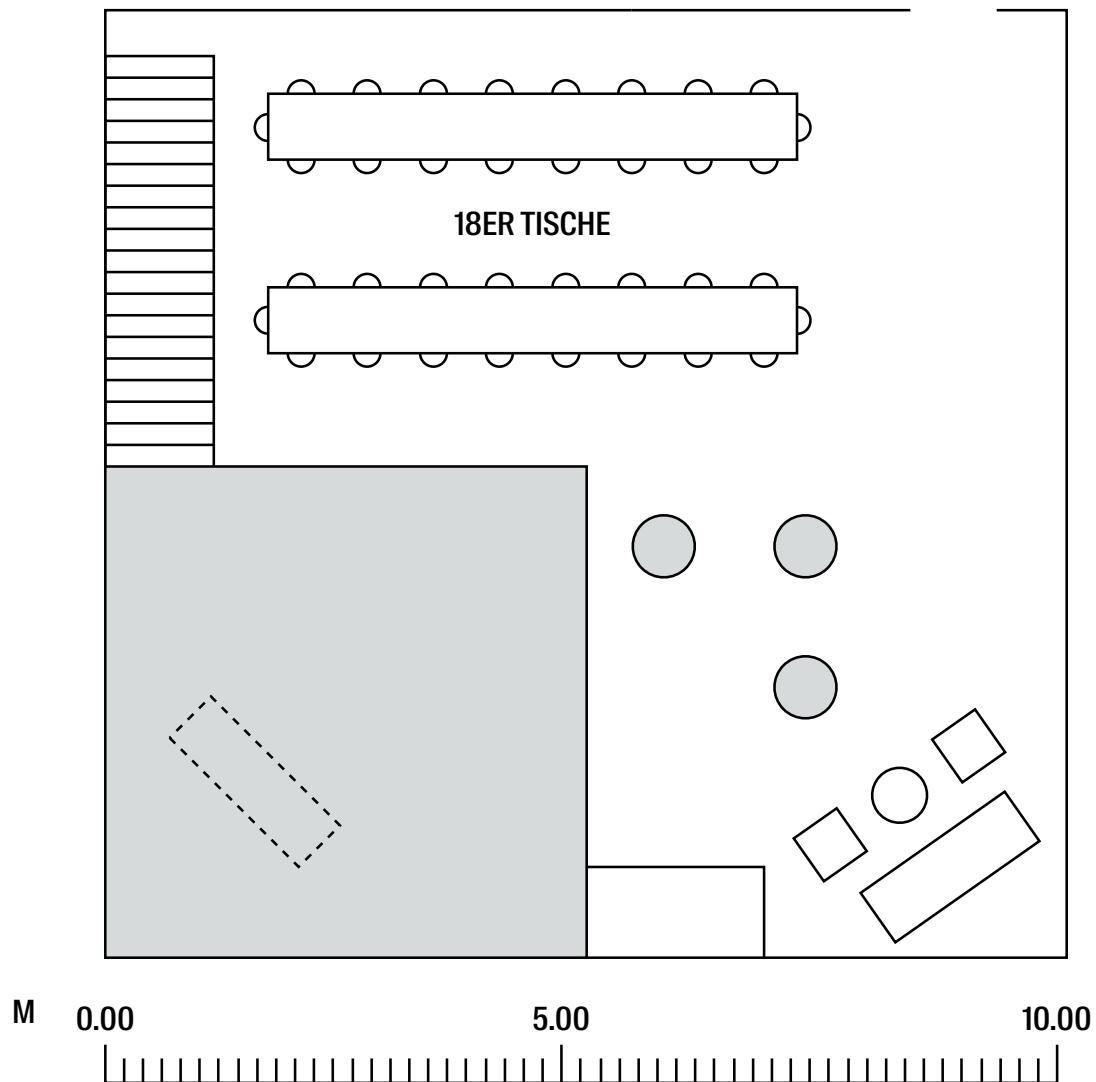

GRUNDRISS PRINTERS

Grösse: 100 m²
Setting: Dinner
Personen: 40





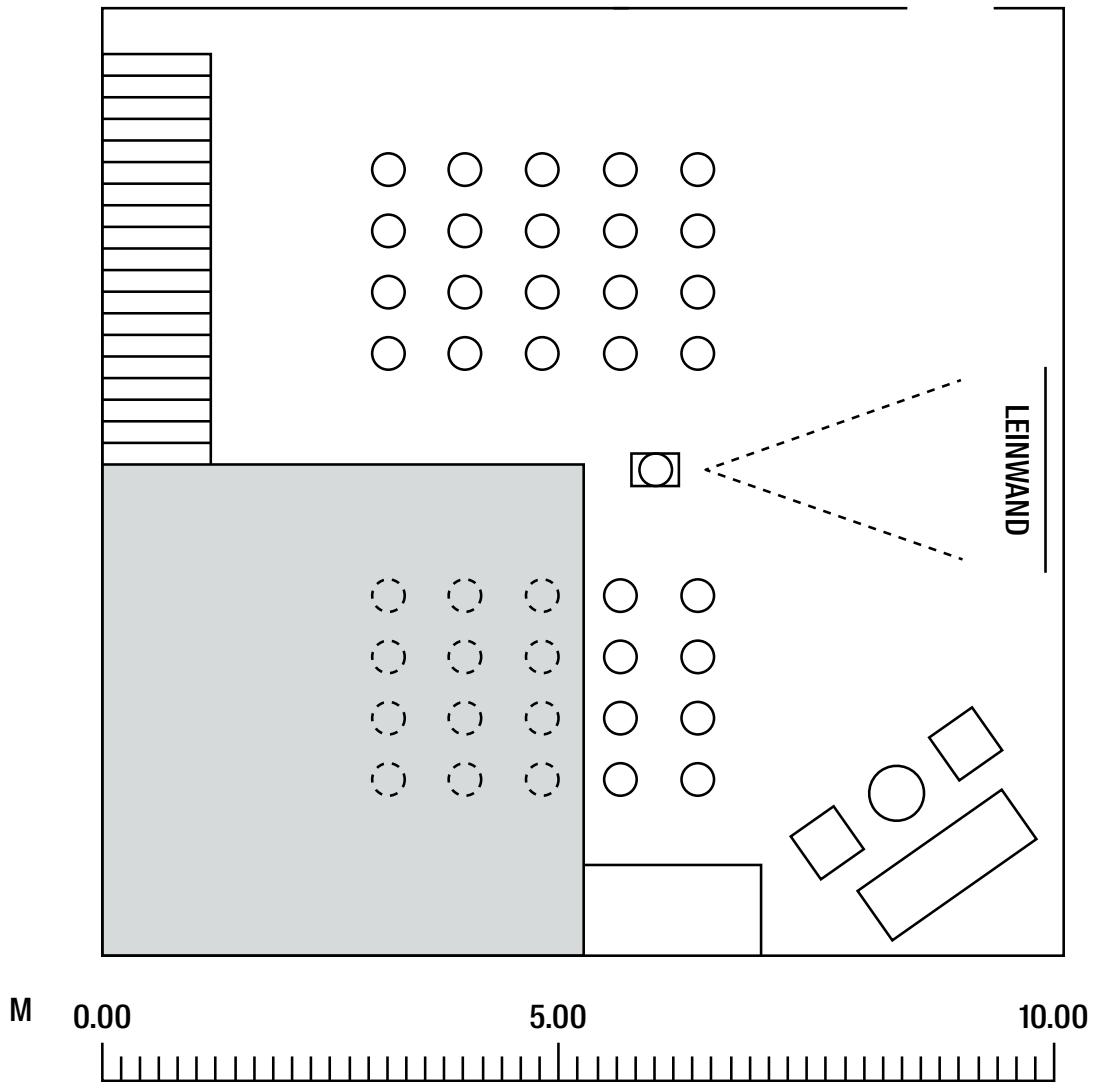

-  Lounge
-  Treppe
-  2. Stock
-  Barelement
-  Weinfass

GRUNDRISS PRINTERS

Grösse: 100 m²
Setting: Konferenz
Personen: 40







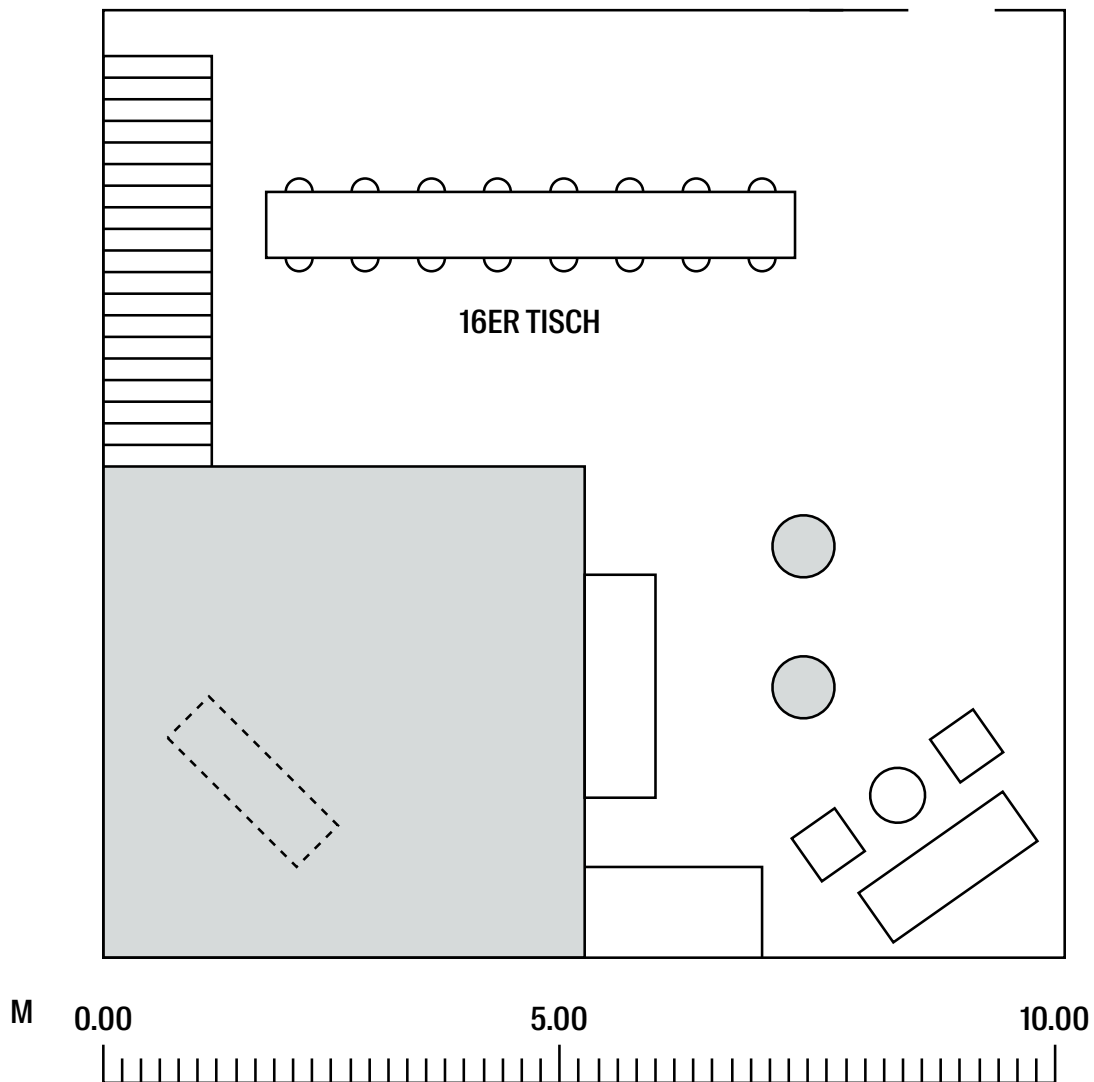

-  Lounge
-  Treppe
-  2. Stock
-  Beamer
-  Stuhl

GRUNDRISS PRINTERS

Grösse: 100 m²
Setting: Stehend
Personen: 80





- | | | | |
|--|----------|---|------------|
|  | Lounge |  | Barelement |
|  | Treppe |  | Weinfass |
|  | 2. Stock |  | Hochtisch |

GRUNDRISS PRINTERS

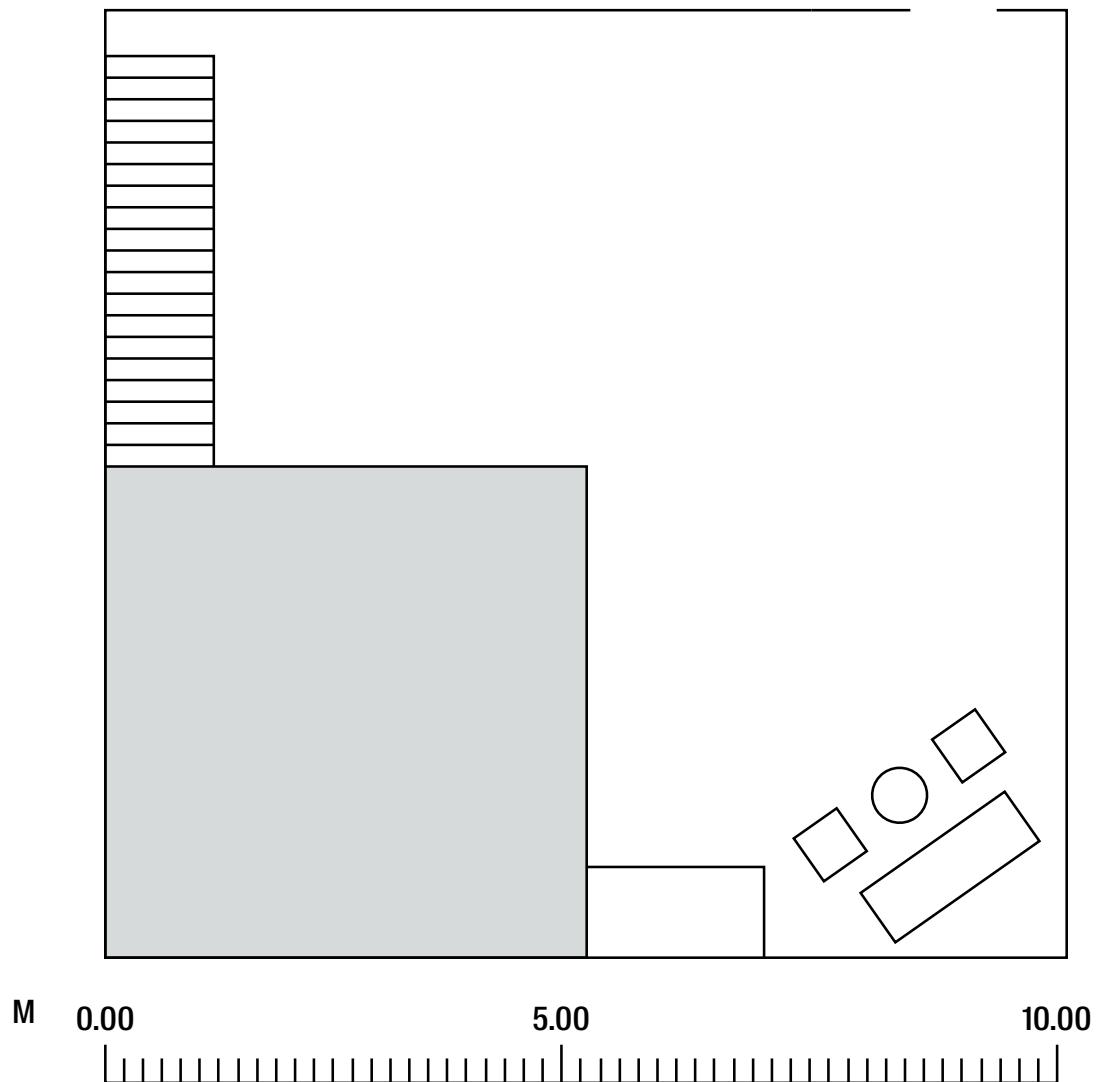
Grösse: 100 m²
Setting: Leer



-  Treppe
-  2. Stock

GRUNDRISS GALLERY

Grösse: 280 m²
Setting: Dinner mit Tanzfläche
Personen: 88

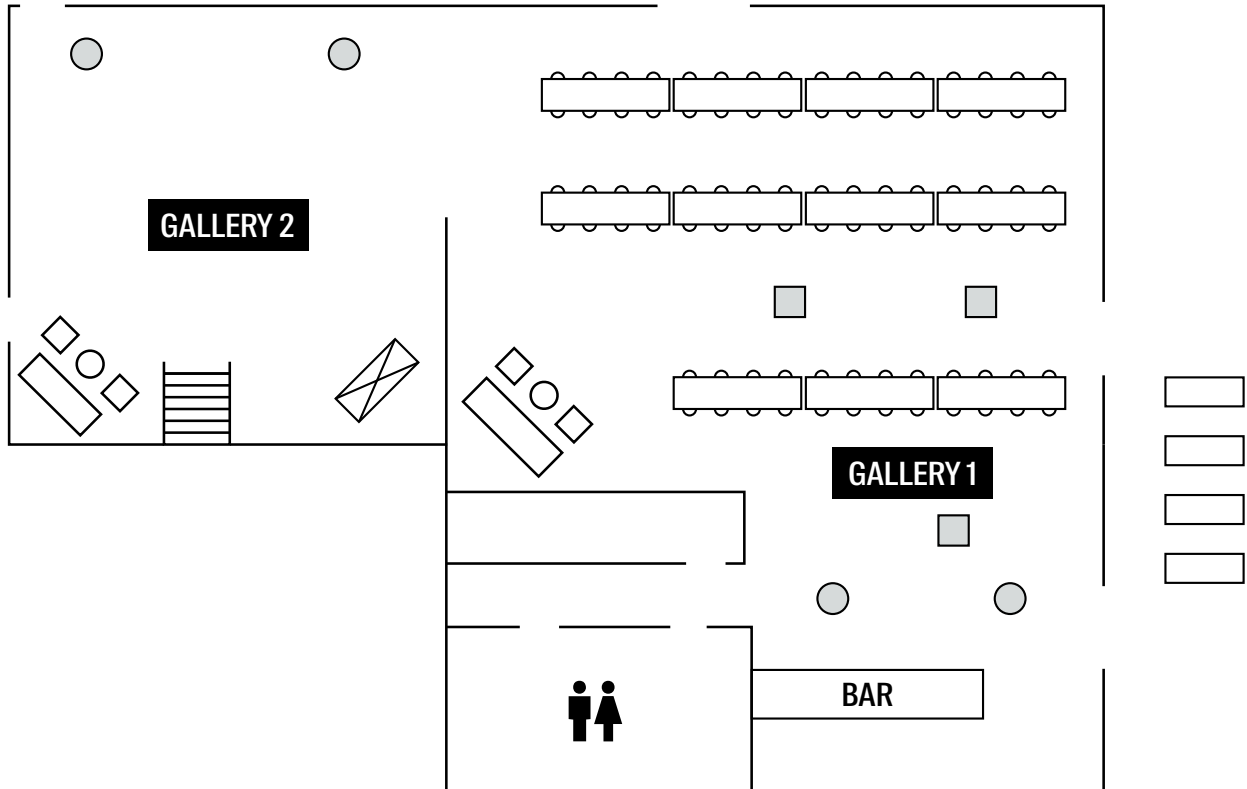

- Säule
- Weinfass
- Lounge
- ▩ Treppe
- ⊠ DJ Pult
- ▭ Hochtisch
- ♂♀ Toiletten

GRUNDRISS GALLERY

Grösse: 280 m²
Setting: Konferenz
Personen: 100

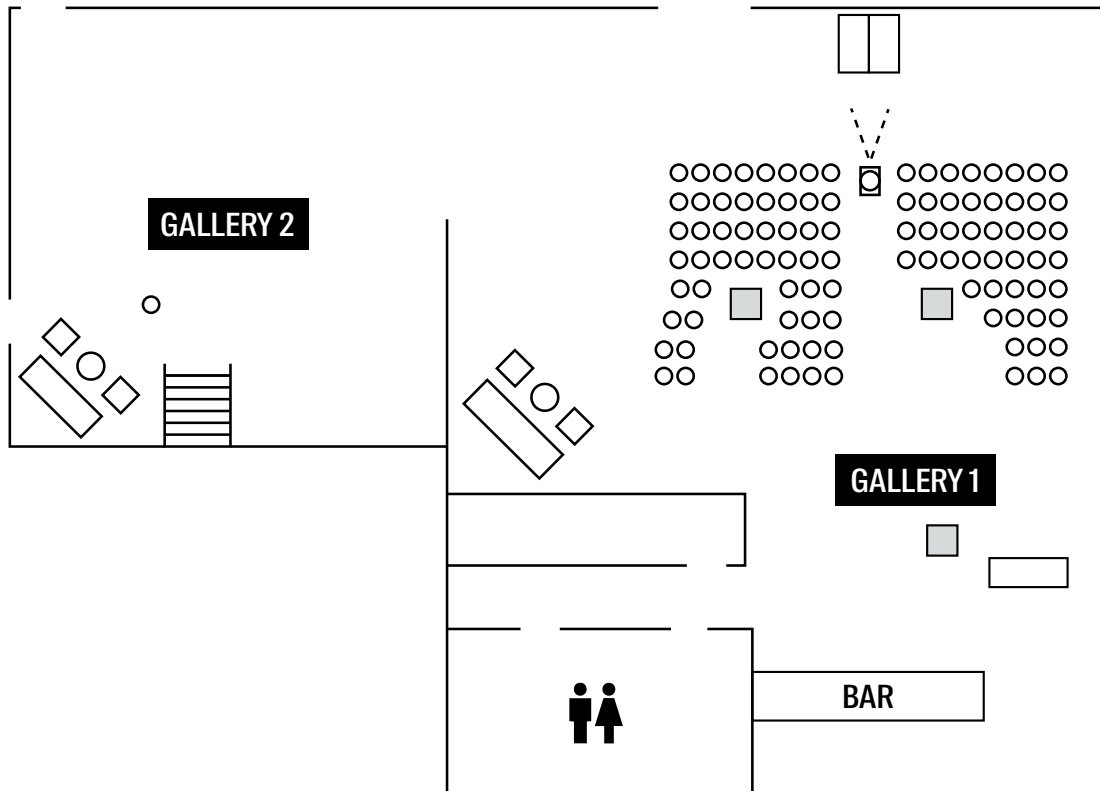

- | | | | |
|--|--------|--|-----------|
| | Beamer | | Stuhl |
| | Bühne | | Säule |
| | Lounge | | Hochtisch |
| | Treppe | | Toiletten |

GRUNDRISS GALLERY

Grösse: 280 m²
Setting: Dinner
Personen: 150

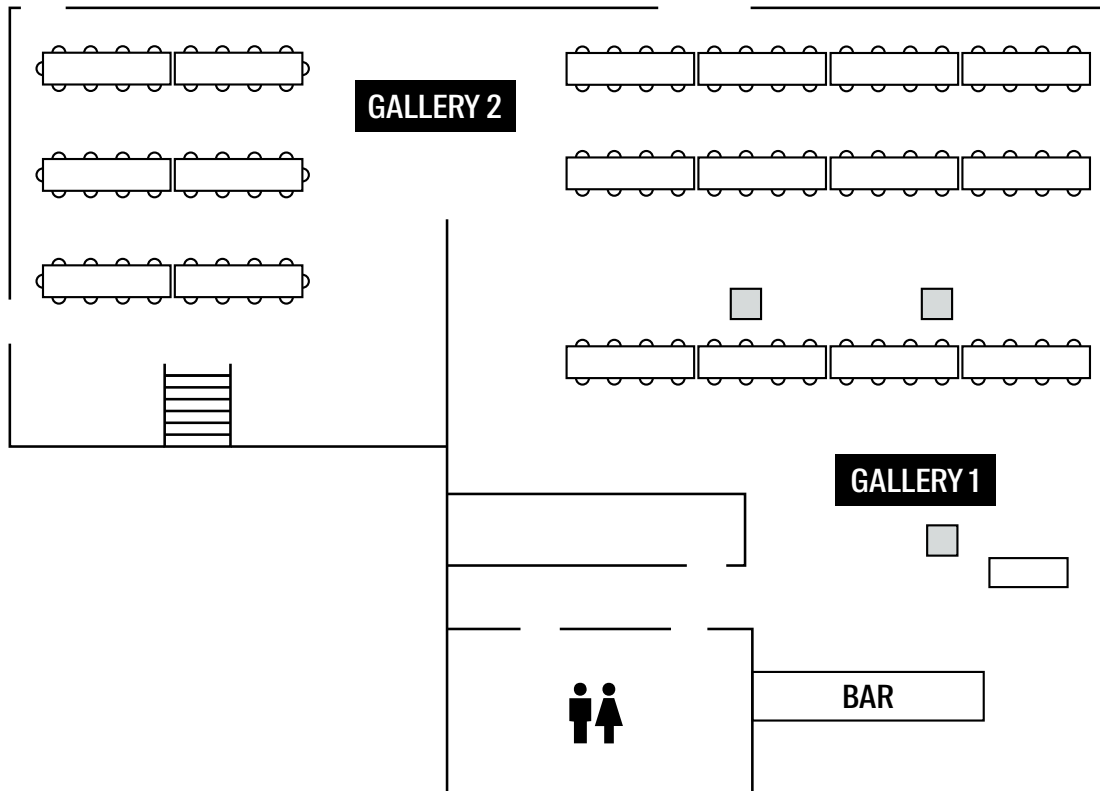

-  Säule
-  Hochtisch
-  Toiletten
-  Treppe

GRUNDRISS GALLERY

Grösse: 280 m²
Setting: Stehend
Personen: 250

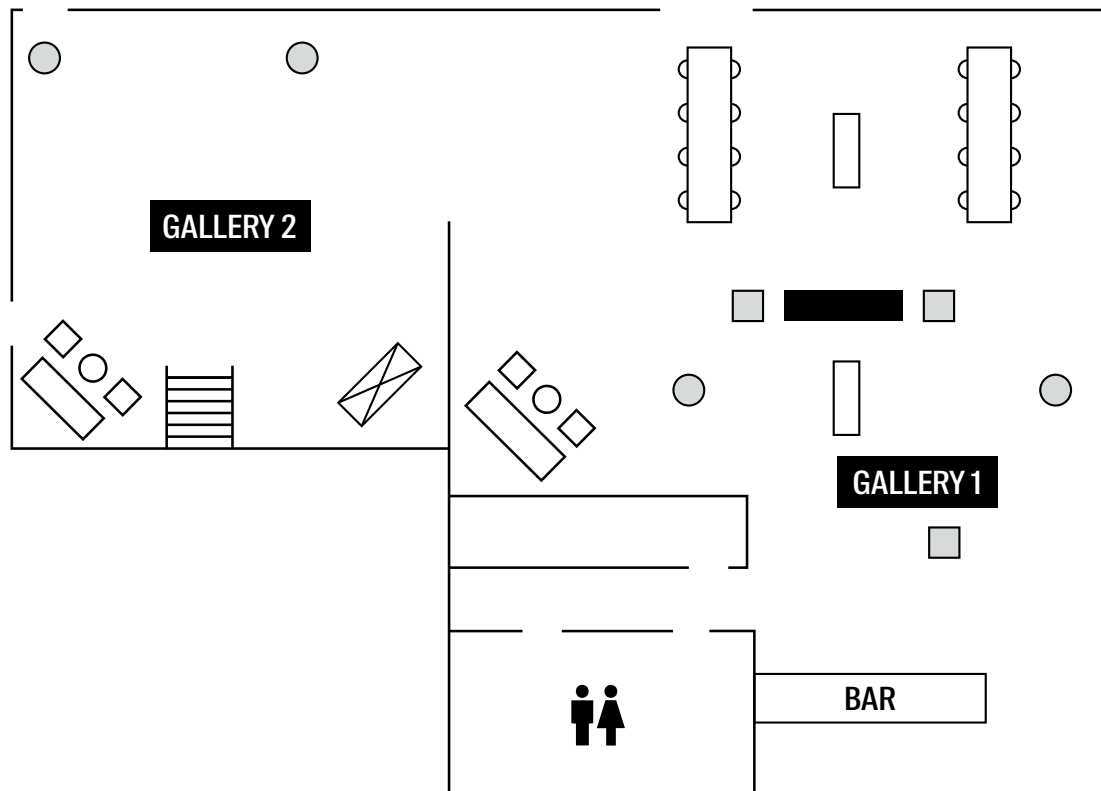

M 0.00 5.00 10.00 15.00 20.00 25.00

- | | | | |
|-----|---------|----|-----------|
| ■ | Säule | ⊠ | DJ Pult |
| ● | Weinfaß | ♂♀ | Toiletten |
| □○□ | Lounge | □ | Hochtisch |
| ▮ | Treppe | ■ | Sideboard |

GRUNDRISS GALLERY

Grösse: 280 m²

Setting: Leer

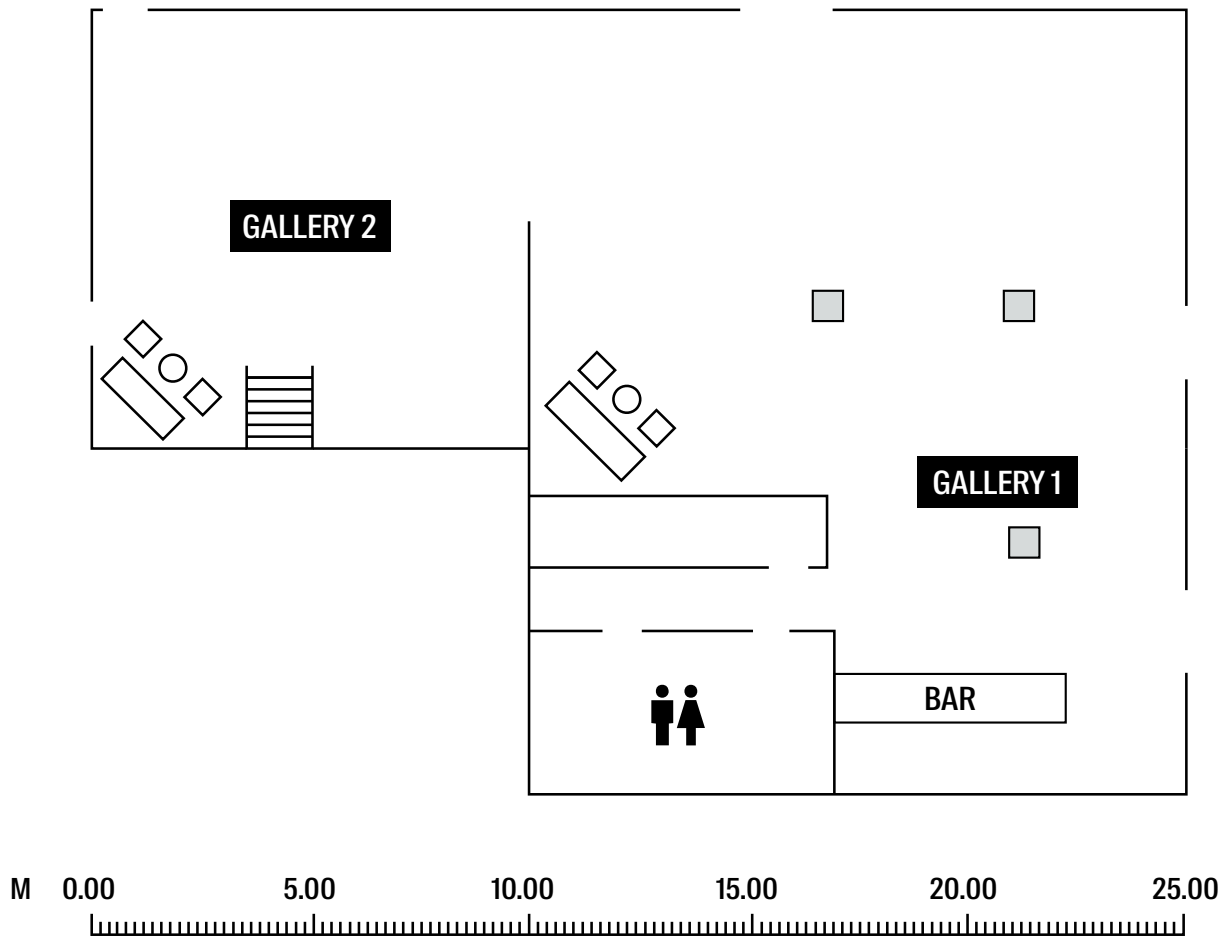

 Toiletten

 Säule

 Treppe

GRUNDRISS ATELIER

Grösse: 60 m²
Setting: Workshop
Personen: 4-25

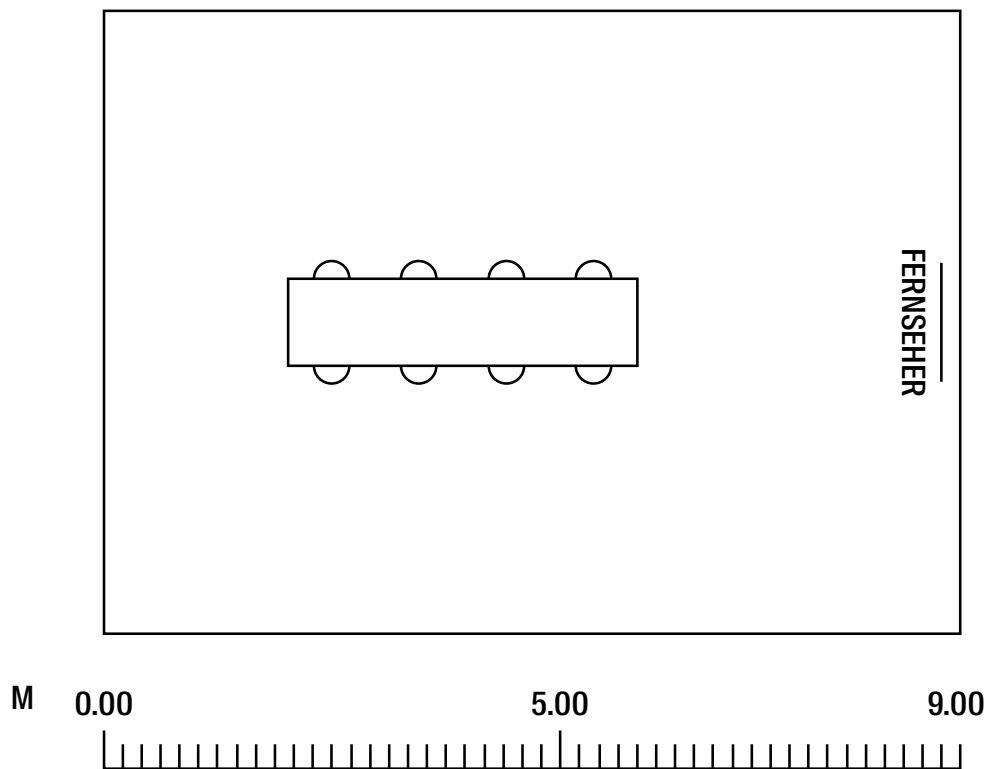

GRUNDRISS ATELIER

Grösse: 60 m²
Setting: Leer

